



Z-CAM

All Original Numbers, Marks and Models from
Vehicle Manufacturers Listed in this catalogue
are for comparison purposes only



www.brakingtech.com



BTG01001

Description :

Grease Oil(White)

Application : :

Content is 5gr.For metal&rubber items in Airbrake system

OEM No :

1114525, 1132868, K93430, 1132793, S-29152-12



BTZ60001

Description :

Return Spring

No	BT No	Information
1	BTT251 x 1	Return Spring

Application : :

FORD,DAF,DENNIS,ERF,RENAULT,VOLVO,BMC,RAI

OEM No :

167090, 68192115, 9C462296AA, 665153,
1892003407951, 1398023, 8607130, 1694362,
1696444, 3097092, 5006 018 480, 3346437R1,
9P901265, 61385919, 65399619, 2900000088,
5001 868 113



BTZ60002

Description :

Return Spring Pin

No	BT No	Information
1	BTT252 x 1	Return Spring Pin

Application : :

VOLVO,RABA,FORD,BMC

OEM No :

368192487, 0972299, 1698346, 9C462069AA,
3097299, 1696445, 137075, 68200150



BTZ60003

Description :

Adjusting Pinion(L/H)

No	BT No	Information
1	BTT253 x 1	Adjusting Pinion

Application : :

VOLVO,RENAULT,MAN

OEM No :

3090997, 1081819, ST1038, 68020145, 1606775,
5006 046 765, 1428741

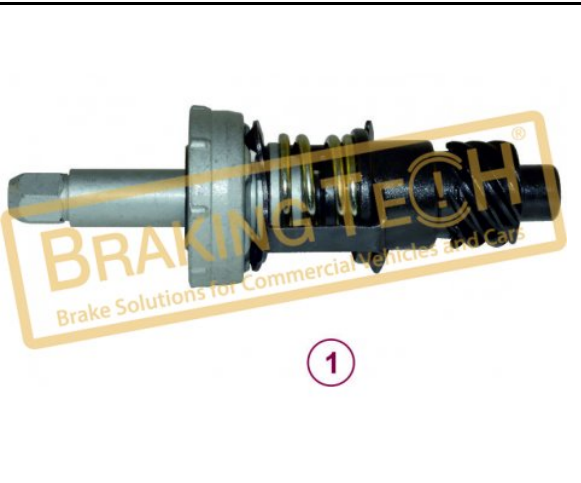

BTZ60004

Description :
 Adjusting Pinion(R/H)

Application :
 VOLVO,RENAULT,MAN

OEM No :
 3090998, 1081820, ST1039, 68020146, 1607502,
 5006 046 766, 1428758, N2509996051

No	BT No	Information
1	BTT254 x 1	Adjusting Pinion



BTZ60005

Description :
 Cross Shaft

Application :
 MAN,MB,AWD,DAF,Ford,Iveco,RENAULT,Dennis

OEM No :
 68191219, 272910, 5001868121, 9C462458AA,
 SP8540, ST4018, 8603403, N2509996050,
 1696453, 3098271, 5006 018 458, 65399621,
 1892003407351, 1422829, 1694368, 5001 868 121,
 3346443R91, 6138597, A4027696

No	BT No	Information
1	BTT255 x 1	Cross Shaft



BTZ60006

Description :
 Thrust Pin

Application :
 VOLVO,RENAULT,FORD,RABA,DENNIS,DAF,MAN,IV

OEM No :
 137074, 64225252, N2970060001, 5006 018 440,
 60889335, 61049727, AAU6457, 1696446,
 6138599, 1694355, 5001 868 120, 16352S1,
 1892003407251, 665152, 9C462B003AA,
 8603393

No	BT No	Information
1	BTT256 x 1	Thrust Pin



BTZ60007

Description :
 Brake Adjusting Gear (Right)

Application :
 MB,VOLVO,RENAULT,DAF,MAN,LEYLAND,BMC,DEI

OEM No :
 68192566, 272908, 3097100, 8550977,
 9C462A105BA, ST4013, ST4024, A164062, MAN
 1472809, 8603390, N2509996054, 5006 018
 437, 65399612, XBU0911, PPMST4013, 61385911,
 9P910414, 3348784R91, 1892003407221,
 3098277, 5001 868 117, 1694353

No	BT No	Information
1	BTT257 x 1	Adjusting Gear



BTZ60008

Description :
 Brake Adjusting Shaft(Left)

Application :
 MB,VOLVO,RENAULT,DAF,MAN,LEYLAND,BMC,DEI

OEM No :
 68162565, 272909, 3097099, 8550978,
 9C462A105AA, ST4014, ST4023, A164061,
 68192565, N2509996057, 5006 018 438,
 3348783R91, 65399613, ZF 0501210719,
 1892003407231, 8603391, 9P911107, 1494055,
 1694352, XBU0910, 665135, 3346429R91,
 61385913, 3098276, PPMST4014, 5001 868 118

No	BT No	Information
1	BTT258 x 1	Adjusting Gear



BTZ60009

Description :
 Brake Adjusting Shaft Cover

Application :
 VOLVO,RENAULT,IVECO,DENNIS,MAN,DAF,MB

OEM No :
 SerinFren

No	BT No	Information
1	BTS85 x 1	Gear Cap
2	BTK91 x 1	O-ring



BTZ60010

Description :
 Lock Cap Repair Kit (Thick Thread-14 Thread)

Application :
 VOLVO F10,MAN

OEM No :
 276099, 85.50001.3424, 8604735, 2068777,
 ST1034

No	BT No	Information
1	BTK90 x 1	O-Ring
2	BTT259 x 1	oem:68191930-5006018450
3	BTK91 x 1	O-Ring
4	BTT268 x 1	Cap (Thick Thread) 14 Tee ...
5	BTK92 x 1	O-Ring



BTZ60011

Description :
 Lock Cap Repair Kit (Thin Thread)

Application :
 MAN,DAF,PACCAR,DENNIS,IVECO,RENAULT,VOLV

OEM No :
 ST1035, ST4022, ZF 0501210721, 8701361,
 N2509996037, 3090964, 3098275,
 3346439R91, AWD A4027698, 65399615,
 TP02006093, 1694364, 61385915, 276100,
 42540290, 7403 090 964, 1341829

No	BT No	Information
1	BTK90 x 1	
2	BTT259 x 1	Pin oem:68191930-50060184 ...
3	BTK91 x 1	
4	BTT260 x 1	Cap (Thin Thread) 23 Teet ...
5	BTK92 x 1	

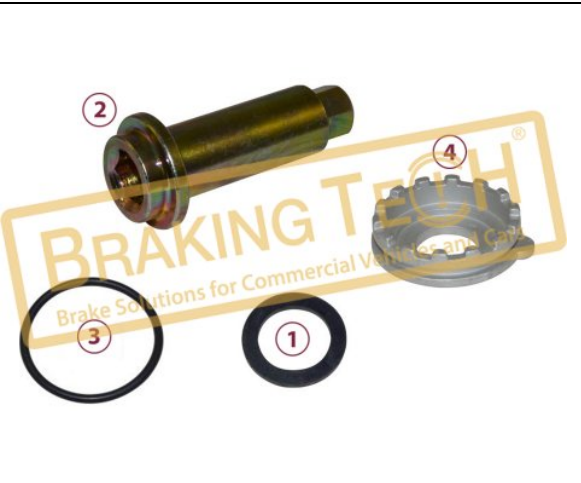

BTZ60012

Description :
 Lock Cap Repair Kit (14 Teeth)

Application :
 VOLVO,MAN,PACCAR

OEM No :
 276096, ST1033, TP02006268, 1449350

No	BT No	Information
1	BTK93 x 1	O-Ring
2	BTT261 x 1	Pin
3	BTK94 x 1	O-Ring
4	BTT262 x 1	Cap (Without Tube) 14 Tee ...

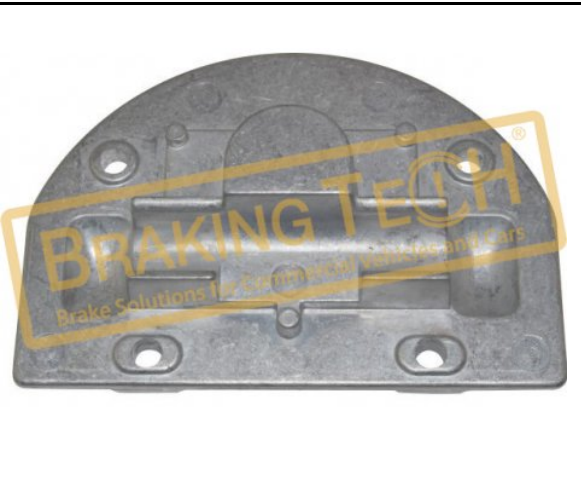

BTZ60013

Description :
 Z-Cam Cover

Application :
 MAN,DAF,BMC,DENNIS,RABA,IVECO,RENAULT,FO

OEM No :
 1696449, 166062, 68191065, 5001 868 127,
 3346423R1, 9C462213AA, 665145, 653996-7,
 1694347, N2900000084, 5006 018 435,
 A4027680

No	BT No	Information
1	BTT263 x 1	Cover

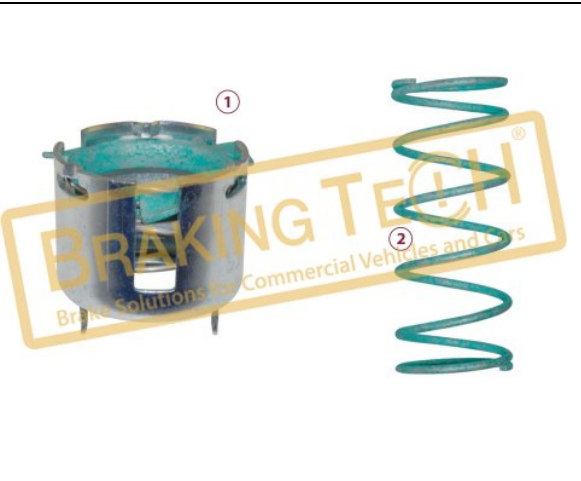

BTZ60014

Description :
 Reverse Lock Repair Kit (Right)

Application :
 MB,VOLVO,IVECO,FORD,DENNIS,RENAULT,BMC,D/

OEM No :
 ST1037, ST4020, 68191541, 1892003407911,
 8604737, N2509996047, 3098273, AWD
 A4027699, 6539973, 6138604, 9C462K400BA,
 9P910412, 1694366, 276098, 7400 276 098,
 3346441R91, 1386099

No	BT No	Information
1	BTSI43 x 1	Locking Shim
2	BTY30 x 1	Locking Spring

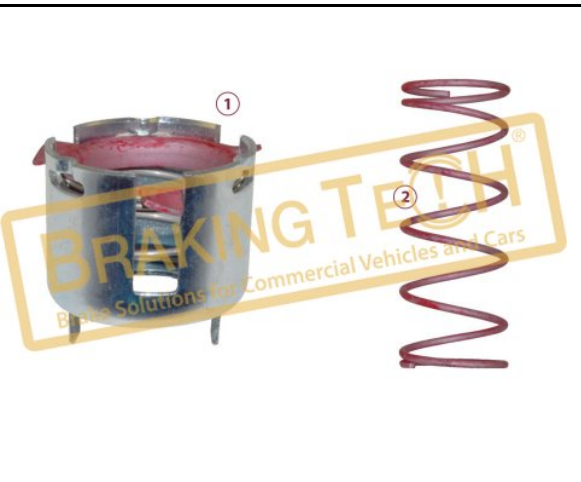

BTZ60015

Description :
 Reverse Lock Repair Kit (Left)

Application :
 MB,VOLVO,IVECO,FORD,DENNIS,RENAULT,BMC,D/

OEM No :
 ST1036, ST4021, PACCAR TP02006094,
 68191540, 8604736, N2509996035, 65399617,
 9C462K400AA, 61385928, 9P910411, A4027706,
 7400 276 097, 3346440R91, 276097, 1694365,
 1336762

No	BT No	Information
1	BTSI43-01 x 1	Locking Shim
2	BTY29 x 1	Locking Spring



BTZ60016

Description :
Brake Adjuster Dust Excluder

Application :
RENAULT,VOLVO,IVECO,FORD,RABA,PACCAR,DAF

OEM No :
68192410, ZF 0501316391, 8701359,
N2509990143, 3090954, 5006 018 439,
3346430R91, AWD A4027686, 65399614 ,
65399620, 89200340815, 9C462B009AA,
1427340, 1694354, 5001 868 119, 1696448,
TP08023002, 42540274, 665151, 61385910

No	BT No	Information
1	BTK95 x1	Dust Cover 36x68x20,40

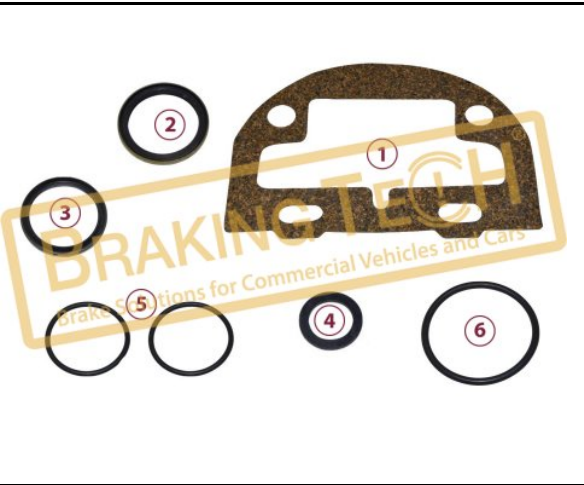

BTZ60017

Description :
Brake Cover Plate Seal Kit

Application :
MAN,AWD,DENNIS,BMC,DAF,RENAULT,VOLVO

OEM No :
272905, ST4025, ST1053, 8701362, 5006 018 459,
3098290, 9P905487, A4027695, 613859-23,
1694370, 653563-8, 1422835, N2965026017

No	BT No	Information
1	BTCN4 x1	Gasket
2	BTK89 x1	Seal 38x47,68x4,80/5,70
3	BTK96 x1	Seal 38x47,68x4,80
4	BTK97 x1	O-Ring
5	BTK98 x2	O-Ring
6	BTK99 x1	O-Ring



BTZ60018

Description :
Pinion (Right) (New Model)

Application :
RVI,VOLVO,LEYLAND
DAF,PACCAR,FORD,MAN,MB,IVECO

OEM No :
A164055, 68191511, 1892003407941, 8605967,
N2509990131, 3346449R1, AWD A4027691,
6539963, 6539975, 1696925, 89200340794,
TP02006096, 9C462K161AA, 3346447R1,
6138606, XBU0685, 5001 868 126, 1350890,
1694794

No	BT No	Information
1	BTT264 x1	Pinion

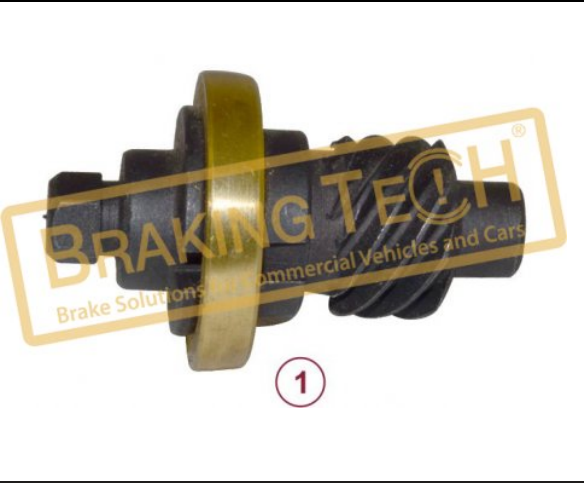

BTZ60019

Description :
Pinion (Left) (New Model)

Application :
RVI,VOLVO,LEYLAND
DAF,PACCAR,FORD,MAN,MB,IVECO

OEM No :
A164052, 68191510, 1892003407931, 8605966,
N2509990129, 5001868125, 5006 018 474, AWD
A4027705, 65399625, 1696924, 89200340793,
9C462K161BA, 3346448R1, XBU0684, 61385929,
1350884, 1694793, 5001 868 125, TP02006095

No	BT No	Information
1	BTT265 x1	Pinion



BTZ60020

Description :
 Pinion (Left) (Old Model)

Application : :
 Meritor,FORD,RVI

OEM No :
 68191511, 1696925, 5001868125, 9C462K161AA

No	BT No	Information
1	BTT266 x1	Pinion



BTZ60021

Description :
 Pinion (Right) (Old Model)

Application : :
 Meritor,FORD,RVI

OEM No :
 68191510, 1696924, 9C462K161BA

No	BT No	Information
1	BTT267 x1	Pinion



BTZ60022

Description :
 Brake Cover Plate Gasket

Application : :
 VOLVO,RENAULT,LEYLAND
 DAF,FORD,MAN,DENNIS

OEM No :
 1696450, 166063, 5001 868 122, 9C462B032AA,
 XBU0889, 653996-8, 1694348, 1321234,
 8603385, N2966010119, 5006 018 436, 613859-4,
 653563-15

No	BT No	Information
1	BTCN4 x1	Gasket



BTZ60023

Description :
 Spring Holder

Application : :
 VOLVO,RENAULT,LEYLAND DAF,FORD,MAN

OEM No :
 5001 868 128, 681 92 612

No	BT No	Information
1	BTT226 x1	Metal Shield Holder



BTZ60024

Description :
 Bushing Sac

Application :
 Volvo BUS,RENAULT,LEYLAND DAF,FORD

OEM No :
 1517531, 5001 868 163, 681 91 518, 1088812

No	BT No	Information
1	BTB39 x 1	Bushing 38X43X26 MM



BTZ60025

Description :
 Seal Sac

Application :
 VOLVO,RENAULT,LEYLAND DAF,FORD,MAN

OEM No :
 5001 868 162, 682 00 114

No	BT No	Information
1	BTK155 x 1	Seal



BTZ60026

Description :
 Brake Adjusting Gear Cap Set

Application :
 MB,DAF,MAN,VOLVO,IVECO,RENAULT,DENNIS,AW

OEM No :
 272904, 3098272, SP7984, ST4019,
 89200340751, 1892003407511, 1376916,
 N2900006011, 1694367, 5006 018 457,
 3346442R91, A4027697, 61385912, 65399616

No	BT No	Information
1	BTS85 x 2	Gear Cap
2	BTK91 x 2	O-Ring

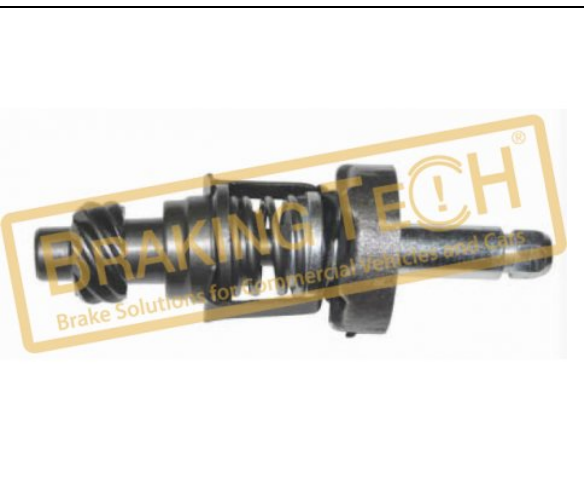

BTZ60027

Description :
 Brake Adjustment old (R/H)

Application :
 Meritor,VOLVO,RENAULT

OEM No :
 1607502, 68020146, 5006 046 766

No	BT No	Information
1	BTT254-01 x 1	Adjuster Pinion



BTZ60028

Description :
 Brake Adjustment old (L/H)

No	BT No	Information
1	BTT253-01 x 1	Adjuster Pinion

Application :
 Meritor,VOLVO,RENAULT

OEM No :
 1606775, 68020145, 5006 046 765



BTZ60029

Description :
 Brake Bracket Volvo(R/H)

Application :
 Meritor(Ø410),VOLVO FH12

OEM No :
 3092466, 681 92 682



BTZ60030

Description :
 Brake Bracket Volvo(L/H)

Application :
 Meritor(Ø410),VOLVO FH12

OEM No :
 3092466, 681 92 681



BTZ60031

Description :
 Brake Pinion Repair Kit (Left)

No	BT No	Information
1	BTT265 x 1	Pinion (Left)
2	BTT261 x 1	Pin
3	BTK94 x 1	O-Ring
4	BTK93 x 1	O-Ring
5	BTS143-01 x 1	Locking Shim (Left)
6	BTY29 x 1	Locking Spring

Application :
 VOLVO F10,MAN,RENAULT

OEM No :
 SP8548, 272906, 5021 203 714, 1322422,
 N2509996031

BTZ60032



Description :
 Brake Pinion Repair Kit (Right)

Application : :
 VOLVO F10,MAN,RENAULT

OEM No :
 SP8549, 272907, 1322439, N2509996033

No	BT No	Information
1	BTT264 x 1	Pinion (Right)
2	BTT261 x 1	Pin
3	BTK94 x 1	O-Ring
4	BTK93 x 1	O-Ring
5	BTS143 x 1	Locking Shim (Right)
6	BTY30 x 1	Locking Spring

BRAKING TECH®

Brake Solutions for Commercial Vehicles and Cars

www.brakingtech.com

www.serinfren.com

[f /BrakingTech](#)

[s /SerinoTomotiv.Oğuz](#)

[v /Oğuz Serin](#)

[i /brakingtech](#)

[in /BrakingTech-Serin Otomotiv](#)



SERIN

Yedek Parça Otomotiv
San.Tic. A.Ş.

Kemalpaşa Mah. 7105 Sokak No:4 35060 Pınarbaşı
Bornova / İzmir / TURKEY

export@brakingtech.com

[+90 232 478 5657](tel:+902324785657)

[+90 232 478 5658](tel:+902324785658)